



**BIG
HEAD
SCIENTISTS**



BIG HEAD SCIENTISTS

The story of the Scientist Yaqub, creator of the Albinoid Tribe

&

The story of the Scientist Yashmal, redeemer of the Ebonoid Tribe

- *The original story of Yakub (also spelled Yaaqub and Yakub) appears in verses 45 – 99 of this book, and first appeared in the book entitled “**Message to the Blackman**” by **Elijah Muhammad**, where Elijah Muhammad says the story was told to him by his teacher **Fard Muhammad***
- *The origin story (or “prequel”) of Yakub’s tribe and Family appears in verses 1 – 44 of this book, and first appeared in a book entitled “**The Holy Tablets**”, chapter 3 “**The Scientist**”, tablet 4 “**The Disagreeable Cuthites**” by **Dr. Malachi York***
- *The story of Yashmal (or “sequel”) appears for the first time in this book in verses 100 - 170, and was written and developed by **Aswad Nuur Ibn Afrika***

1. Thousands of years ago on this planet we call Earth, our planet was visited by various **Extra-Terrestrial Humanoid** beings who had to leave their planet and seek refuge on Earth because their home planet had been destroyed by Evil
2. When these **Extra-Terrestrial Humanoid** beings arrived on Earth, they choose to take residence inside the center of the Earth, because the surface of the Earth was inhabited by Human beings.
3. At this point in time in Earth's History, the Human beings who lived on the surface of the Earth were all of one Tribe, the **Ebonoid Tribe**

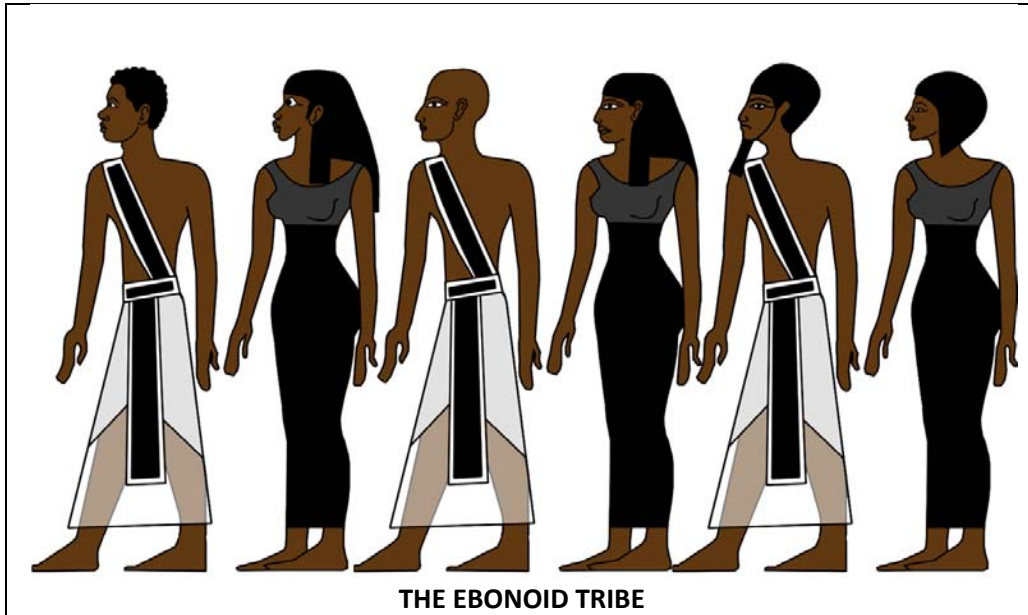

4. Since they live inside the Earth, these extraterrestrial beings (E.T.s) have now become **Inter-Terrestrial Beings** (I.T.s)
5. The **Center of the Earth** where these I.T.s reside also contains an **"Inner Sun"**. The **"Inner Earth"** has been called by a variety of names by cultures around the world including **Shambhala** by **Buddhist**, **Agartha** by **Tibetans**, **Kurnugi** by the **Ancient Mesopotamians**, **Duat** or **Amenta** by the **Ancient Egyptians**, **Hades** or **"the Underworld"** by Europeans, **Xibalba** by the **Mayans**, and in modern times, the concept of the **"Inner Earth"** has given rise to what is called the **"Hollow Earth Theory"**

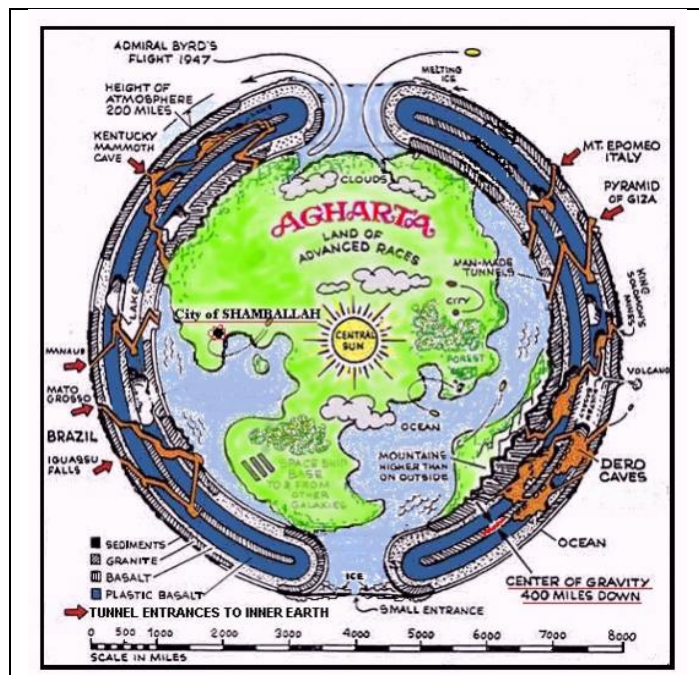

6. Unbeknownst to many Human beings, the activities of these beings which reside inside the Earth has affected the course of Human history and Human development
7. The first and most Noble of the beings which resides inside the Earth is called the **Shuyukh**.
8. Compared to Human beings, the **Shuyukh** would be considered Geniuses with exceptional intellectual abilities and **quasi-telepathic** and **telekinetic** abilities
9. The **Shuyukh** have a dark brown skin completion; they are between 5 ft – 7ft tall; and their heads, brains, and cranial capacity is much wider and larger than the average Human
10. The **Shuyukh** come to the Earth's surface occasionally to teach and to trade with certain tribes of Human beings

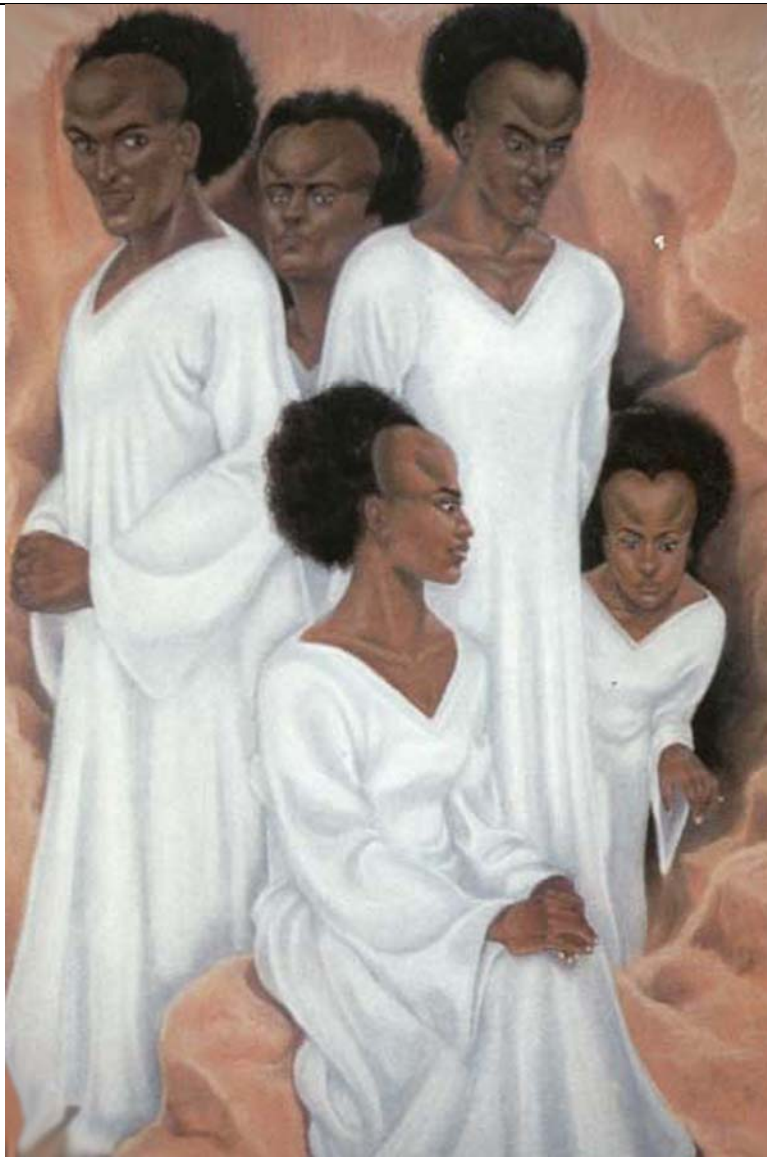

The Shuyukh Tribe

11. The teachings of the **Shuyukh** are so profound that when they come to the Earth's surface to teach, they are often called **Deities, Gods, Priests, Prophets, Messengers, and Seers**, and because of this fact, the Shuyukh have strict laws which limit the interaction of tribal member's contact with the Humans on the surface
12. The Shuyukh commonly interact and have mixed in with the surface world Humans called the **Danakil** (also spelled **Dunaakial**), also known as the **Afar** people, in present day **Eritrea, Djibouti, Ethiopia, and Somalia**
13. The Chief of the **Shuyukh** is named **King Fuquur**, and his daughter is named **Princess Radiyyah**, and two of his brothers are named **Ammo**, and **Yishawk** (who has always been jealous of his brother **King Fuquur**)

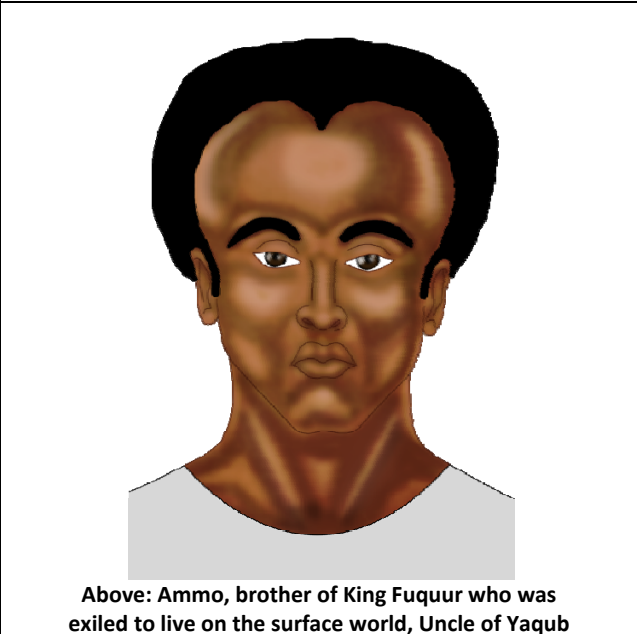
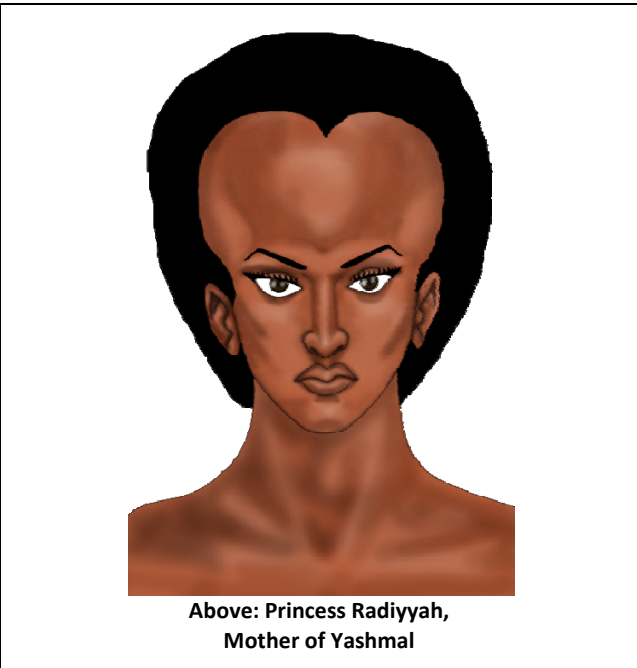
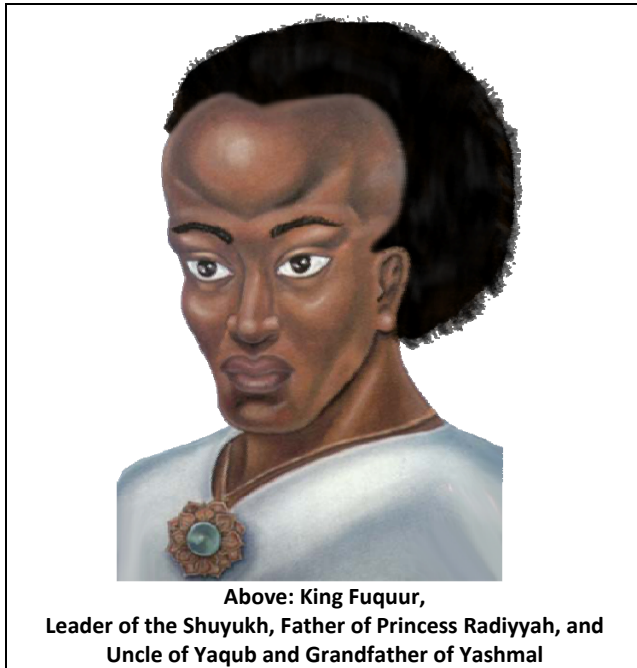

14. **King Fuquur's** brother **Ammo** had fallen in love with a surface dwelling Human female, and he would sneak to the surface world to visit her, and would also pass himself off to the surface dwelling Humans as a **Psychic** and a **Magician**; and for these acts, Ammo was exiled to live on the surface, 20 miles outside of the present day city of **Mecca** in **Saudi Arabia**. As long as the people in the Inner Earth spent most of their life in the Inner Earth, then they will not die, however, to be exiled to the surface world means a person from Inner Earth will eventually die like the mortals on the surface

15. In the caverns adjacent to the **Shuyukh**, resides another group of Nobles called the **Siyniyn**.

16. The **Siyniyn** are also highly intelligent, but also have a fighting spirit. The **Siyniyn** are between 5 ft – 7ft tall and have a variety of complexions from yellow to brown, and they are hairless and are most noted for their cone-shaped heads

17. The **Siyniyn** commonly interact and have mixed with surface world Humans including the **Ancient Egyptians**, the **Olmeccs** in present day **Central America**, the **Mangbetu** people in the **African Congo**, and the **Paracas** people in **Peru**

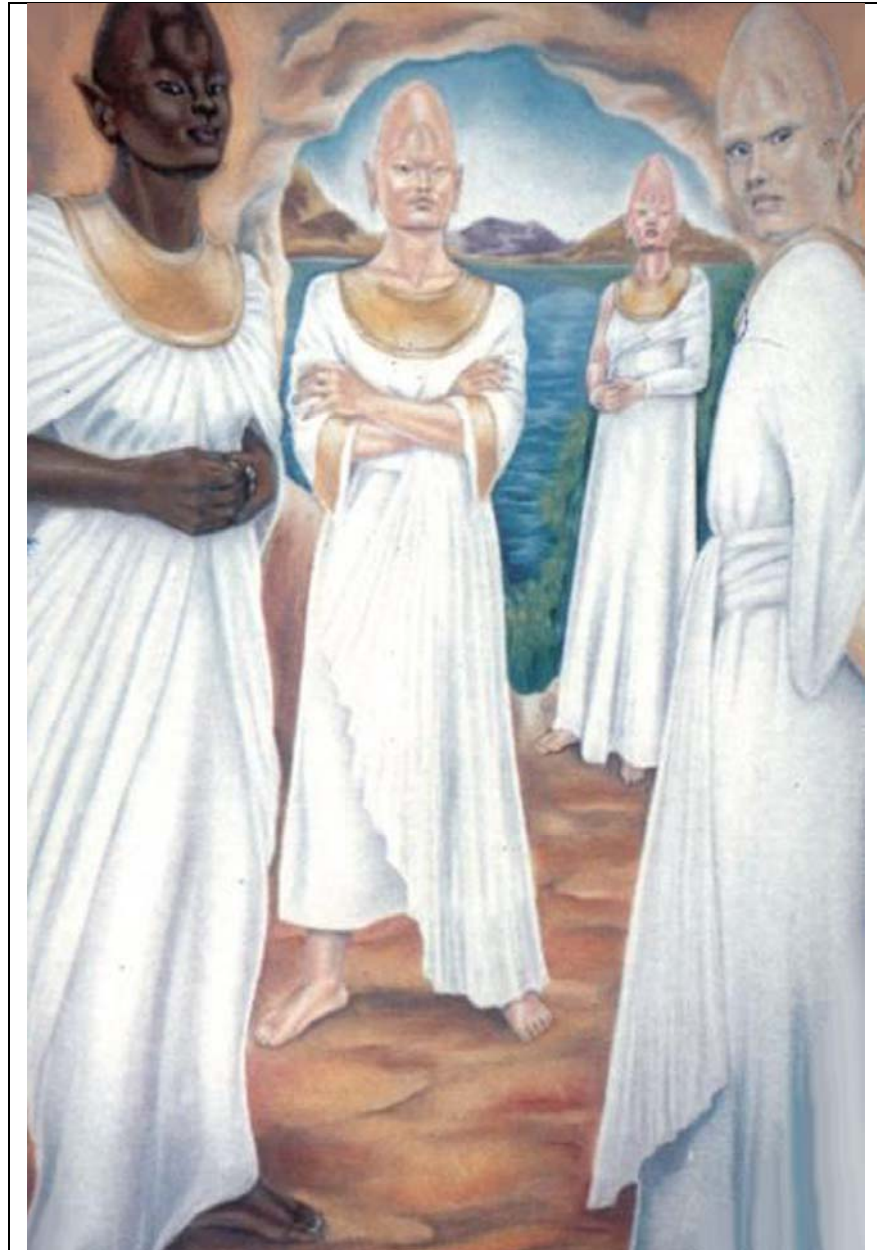

The Siyniyn Tribe

18. The Chief of the **Siyniyn** is named **King Laamsa**, and he has a daughter named **Princess Lusina** and a son named **Prince Haatif**

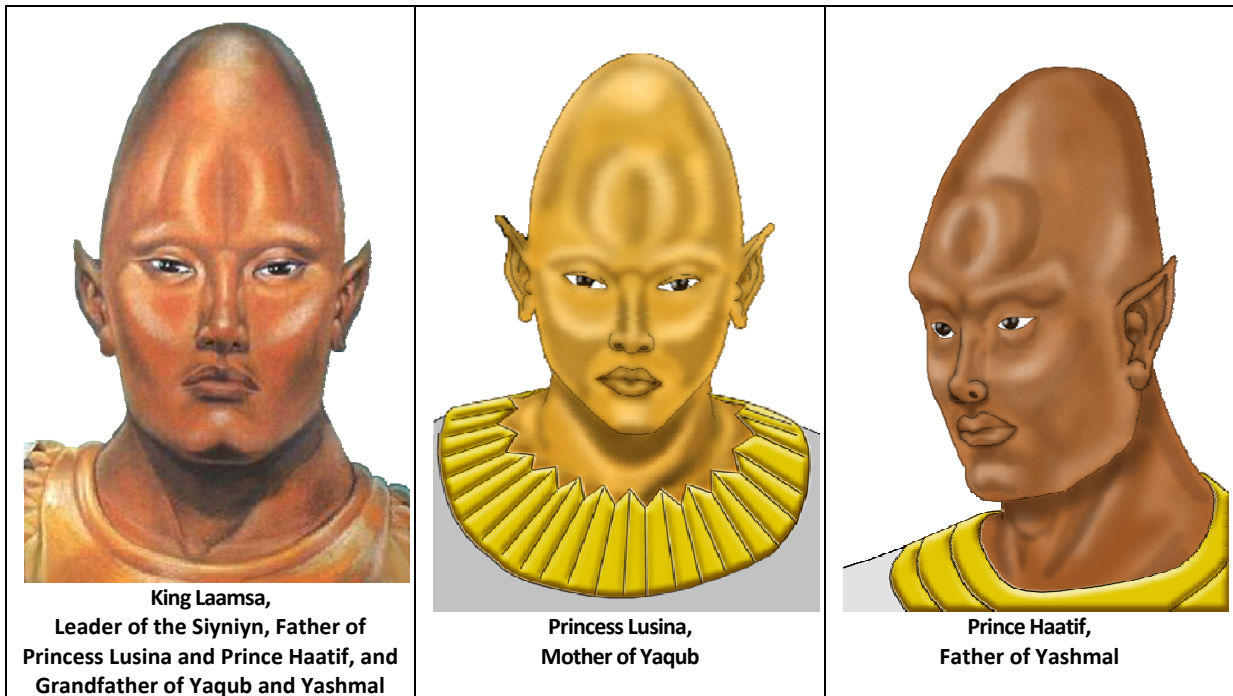

19. One of the wretched group of beings which resides inside the Earth is called the **Saamiyn**

20. The **Saamiyn** are grotesquely obese, pale, with long elephant-like noses, and are very negative and aggressive

21. The **Saamiyn** were actually the manifested Evil grafted out of the Siyniyn on their home world prior to these beings arriving on Earth

22. Since the **Saamiyn** were grafted out of the **Siyniyn**, it is the responsibility of the **Siyniyn** to police and keep in check the evil activities of the **Saamiyn**

23. It is said that an American named **Richard Sharpe Shaver** encountered the **Siyniyn** and called them the "**Teros**" (meaning **Interrogative Robot**) and he encountered the **Saamiyn** and called them "**Deros**" (meaning **Detrimental Robot**)

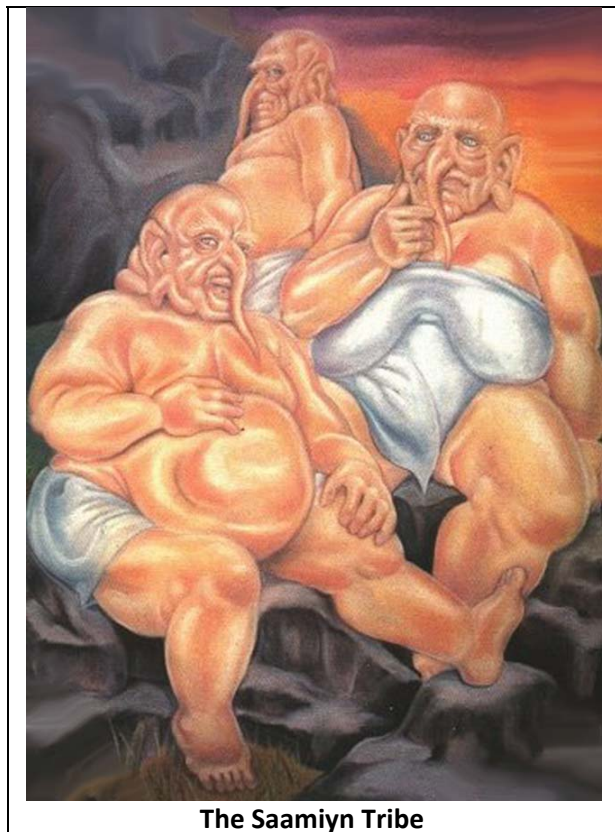

24. One day, the wretched **Saamiyn** raided and invaded the village of the **Shuyukh**, stealing food and terrorizing the **Shuyukh** family
25. When **King Fuquur** learned of this invasion by the **Saamiyn**, he sent a telepathic message to **King Laamsa** stating that the **Siyniyn** has neglected their responsibility to keep the **Saamiyn** in check because the **Saamiyn** were currently raiding and invading the village of the **Shuyukh**
26. Upon receiving the telepathic message from **King Fuquur**, **King Laamsa** went with his brethren to the caverns of the **Shuyukh** to stop the invasion by the **Saamiyn** and to drive the **Saamiyn** back to whence they came
27. After driving the **Saamiyn** away from the lands of the **Shuyukh**, **King Laamsa** apologized to **King Fuquur**, but tension remained between the **Shuyukh** and the **Siyniyn** for some time after the incident
28. In order to make peace between the **Shuyukh** and the **Siyniyn**, **King Laamsa** offered his daughter **Princess Lusina** to be a wife of **King Fuquur**
29. **King Fuquur** accepted the peace offering from **King Laamsa**, and in turn offered his daughter **Princess Radiyyah** to be the wife of **King Laamsa's** son **Prince Haatif** as was the custom; and there was peace in the land for some time between the two tribes of the **Shuyukh** and the **Siyniyn**

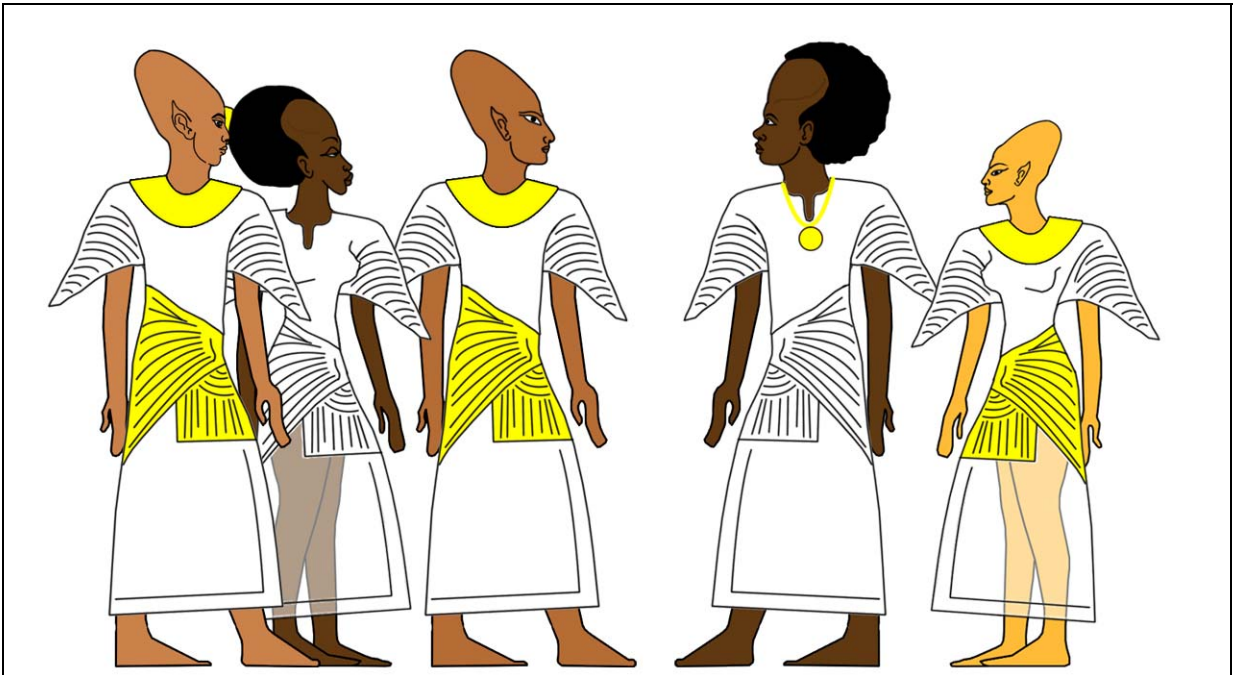

30. However, **King Laamsa's** daughter **Princess Lusina** was angered and outraged because she did not want her father to give her away to be the wife of the **Shuyukh King Fuquur** because she felt like an outcast and out-of-place living amongst the **Shuyukh** people, and she did not like living by the strict laws of the **Shuyukh** people, and she always wanted to marry a man from her own people the **Siyniyn**

31. One day **Princess Lusina**, now the unhappy wife of **King Fuquur**, met **Yishawk**, the jealous brother of **King Fuquur**, and they conspired together based on their hatred for **King Fuquur** to have an illicit sexual affair together behind the back of **King Fuquur**

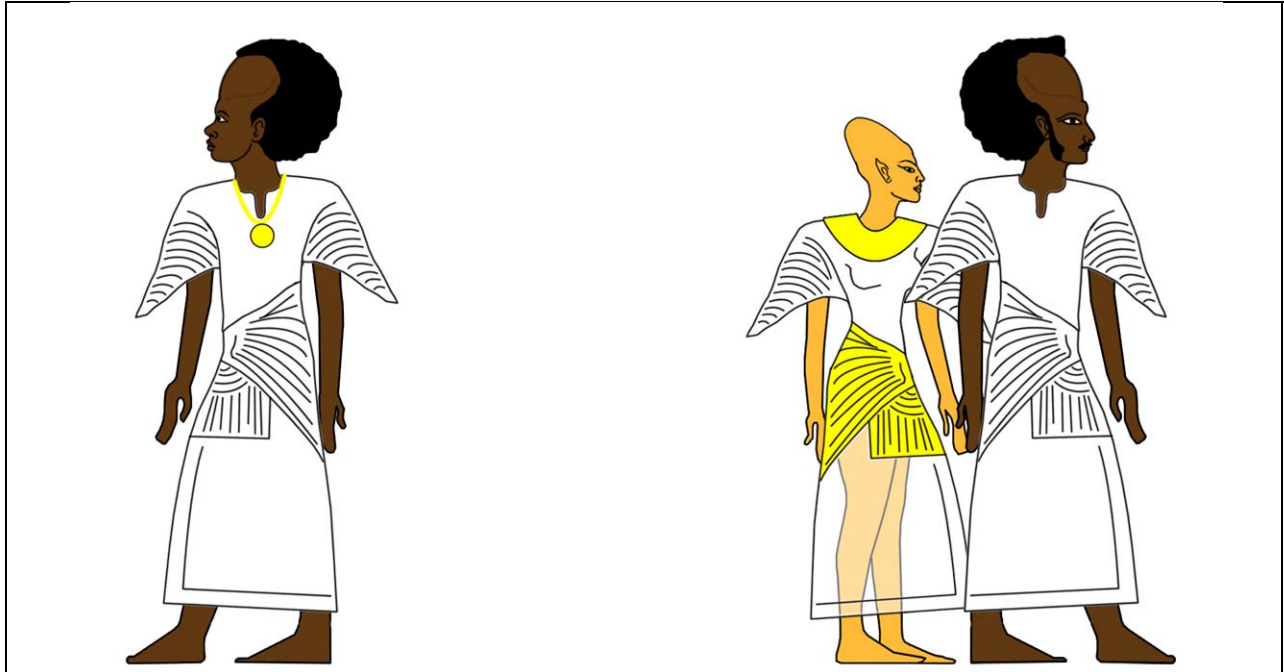

32. **Princess Lusina** and **Yishawk** would travel to the surface world to the home of **Ammo**, the exiled brother of **King Fuquur** and **Yishawk**, and it is here where they would have their illicit affair

33. This affair between **Princess Lusina** and **Yishawk** went on for months with them sneaking back and forth from the inner earth to the surface world, and eventually **Princess Lusina** became pregnant

34. In her pregnant state, **Princess Lusina** would not return to the land of the Inner Earth, but would remain at the home of **Ammo**, and **Yishawk** would stay with her

35. It was here in the home of **Ammo**, 20 miles outside of the present day city of **Mecca Saudi Arabia**, where the child **Yaqub** was born to **Yishawk** and **Princess Lusina**

36. The child **Yaqub** being part **Shuyukh** and part **Siyniyn**, had an enormous head the size of two men, and he also had two brains

37. Knowing that they could not return to the inner earth because their affair had now produced a child, **Yishawk** and **Princess Lusina** decided to live and raise the baby **Yaqub** for 5 years in the home of **Ammo**, 20 miles outside of the present day city of **Mecca Saudi Arabia**



38. **Yaqub's** father **Yishawk** would work as a Scientist and a priest amongst the Humans on the surface calling himself by the title "**Moornuaken, the last high priest**"
39. Back in Inner Earth, **Yishawk** and **Princess Lusina** had been missing for years, and eventually it was found out by **King Fuquur** about the affair between his wife **Princess Lusina** and his brother **Yishawk**
40. **King Fuquur** ordered his soldiers to go to the home of his brother **Ammo** and arrest **Yishawk** for his crime, and according to the laws of the **Shuyukh**, **Yishawk** was put to death
41. **Princess Lusina's** life was spared because she now had a child to take care of, but her punishment was to remain exiled to the surface world living in the home of **Ammo**, and to never return to Inner Earth
42. Depressed about her inability to return home, overwhelmed by her new responsibility to raise a child, and saddened by the death of her lover **Yishawk**, **Princess Lusina** kills herself by committing suicide
43. The 5 year old child **Yaqub**, now an orphan, is raised by his uncle **Ammo**, and the child **Yaqub** is emotionally disturbed and rebellious because of the death of his parents
44. The child grow to hate his people the **Shuyukh**, and all dark complexion people, and blames them for the death of his parents, and desires to have his revenge when he grows up
45. The child **Yaqub** starts school at the age of 4, and is teased and mocked about the size of his head by the surface dwelling Human children, creating low self esteem, and further infuriating the already deranged **Yaqub** fueling his desire for revenge
46. **Yaqub's Uncle Ammo** would tell **Yaqub** stories about the beings in the Inner Earth and how the **Saamiyn** were the manifestation of the Evil grafted out of **Yaqub's** mother's family the **Siyniyn**. One day, when **Yaqub** was 6 years old, he was playing with two magnets in the home of his uncle **Ammo** and noticed the magnetic power of attraction and repulsion that "**unlike attracts, and like repels,**" and by observing this, **Yaqub** was inspired with a **determined idea** to create a Tribe "**unlike**" any of the people on the surface of the planet, and this "**unlike**" Tribe would be **weak and wicked** and attract the other Tribe on the surface of the planet and rule over them with the knowledge of tricks and lies for **6000 years**

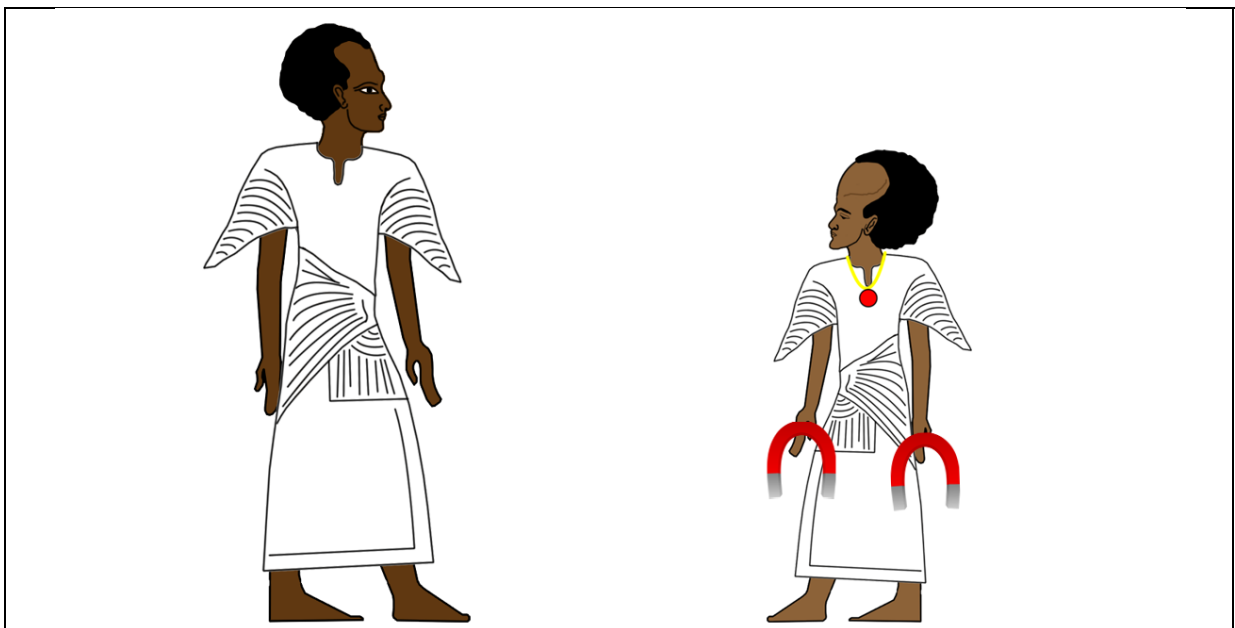

47. Upon coming to this realization, **Yaqub** looked up at his Uncle **Ammo** and said, “Uncle, when I get to be an old man, I am going to make a people who shall rule you”
48. Uncle **Ammo** said: “*What will you make; someone to make mischief and cause bloodshed in the land?*”
49. **Yaqub** responded to his Uncle **Ammo** by saying: “*Nevertheless, Uncle, I know that which you do not know*”, and it was at that moment, the boy **Yaqub** first came into the knowledge of just who he was -- born to make trouble, break peace, kill and destroy, and be the enemy to the **Ebonoid** people of Earth
50. **Yaqub** knew in order to accomplish his plan he would have to study science, biology, and genetics
51. **Yaqub** was a child prodigy in school, being exceptionally smarter than the surface dwelling Humans he was going to school with, and by the age of 18, **Yaqub** had finished all of the colleges and universities of his nation
52. While in college, **Yaqub** was mocked and teased being called “**the Big Head Scientist**”
53. After graduating from the colleges and universities of his nation, **Yaqub** began to preach a new doctrine to the people in the city, which was 20 miles outside of the present day city of **Mecca Saudi Arabia**
54. **Yaqub** called his new Doctrine “**Tricknology**” and his holy book was called **The Book of Tricknology of 120°** and he taught that if people followed his doctrine, then they would be able to rule the world for 6000 years and make slaves out of everyone else on the Earth

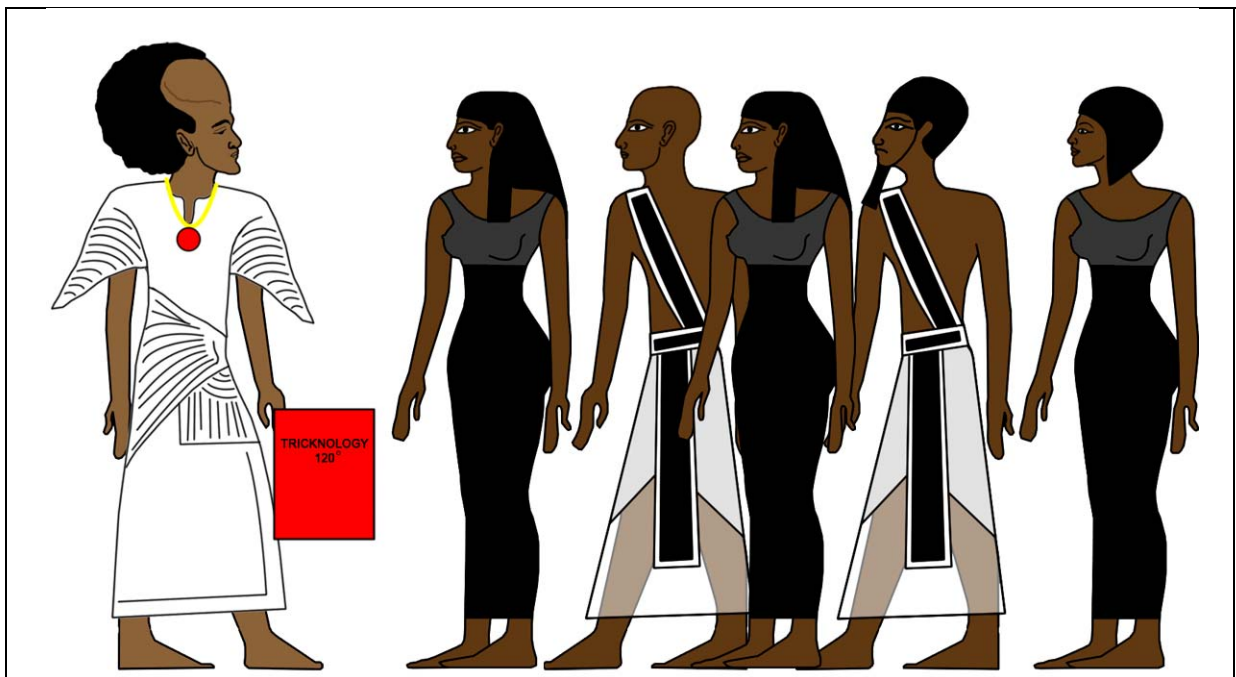

55. **Yaqub** made such impressions on the people that many people began following him; the children who once mocked and teased **Yaqub** were now requesting to be part of what he was teaching; the girls who once laughed at **Yaqub** were now women who desired him
56. As **Yaqub's** teachings spread, he made more and more converts to his new doctrine, and the power of **Yaqub's** doctrine began to intimidate the King of the surface dwelling Humans who ordered to have **Yaqub** and all of his followers thrown in prison
57. The police arrested all of **Yaqub's** followers and put them in prison, and filled up all of the prison cells with **Yaqub's** followers
58. However, there was not enough space to put all of **Yaqub's** followers in jail, therefore there were still some people free who were spreading **Yaqub's** teachings
59. The police notified the King that they did not have enough space for all of **Yaqub's** followers, and at that point the King decided to go to **Yaqub's** prison cell and negotiate a deal
60. The King went to visit **Yaqub** in his prison cell and The King said: *"So you are Mr. **Yaqub**?"* **Yaqub** said: *"Yes, I am"*. The King said: *"**Yaqub**, I have come to see if we could work out some agreement that would bring about an end to this trouble. What would you suggest?"*
61. **Yaqub** said to the King: *"If you give me and my followers everything to start civilization, and furnish us with money and other necessities of life for 20 years, I will take my followers and we will leave"*

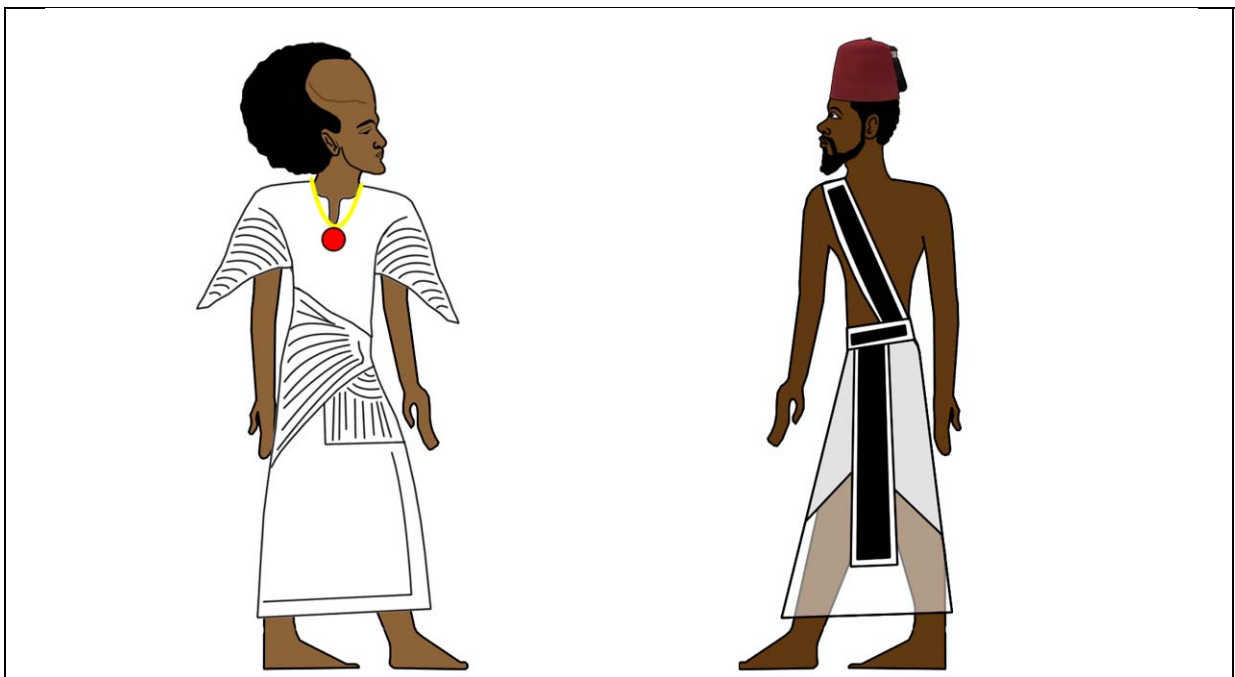

62. The King was pleased with the deal offered by **Yaqub**, and agreed to take care of them for twenty years, until **Yaqub's** followers were able to go for themselves

63. After 20 years, the Government began to make preparation for the exiling of **Yaqub** and his followers. The King ordered everyone rounded up who was a believer in **Yaqub's** doctrine and they took them to the seaport and loaded them on ships.

64. When **Yaqub** and his followers departed there were a total of 59,999 followers plus **Yaqub** making 60,000 total people on 100 ships.

65. **Yaqub** and his fleet of ships departed from an area 20 miles outside of the present day city of **Mecca, Saudi Arabia**, and set sail on the Red Sea, and sailed all the way around the continent of Africa to go to their destination which was the area which is currently called **the Island of Patmos** in the **Aegean Sea**

66. While on the ships sailing around

Africa to get to the area which is currently called **the Island of Patmos**, **Yaqub** began the second part of his plan which was a **Eugenics Human-graftation experiment**

67. Even though all of the people on the surface of the Earth were of one tribe, the **Ebonoid** Tribe, there was still some variation within the **Ebonoid** tribe, and **Yaqub** began to highlight these differences, and **Yaqub** taught these people that they were special, because **Yaqub** planned to use them to graft his new tribe

68. **Yaqub** developed his theory by studying his own genetics under the microscope and noticing that there were two different genes in him, one gene that was Dark from his father **Yishawk's** family the **Shuyukh**, and the other that was not Dark from his mother **Princess Lusina's** family the **Siyniyn**

69. **Yaqub** began to have children with the women on this ship, and the babies which were born that were a lighter complexion he would spare their life, but the babies which were born which were of a darker complexion, **Yaqub** would have thrown overboard into the ocean



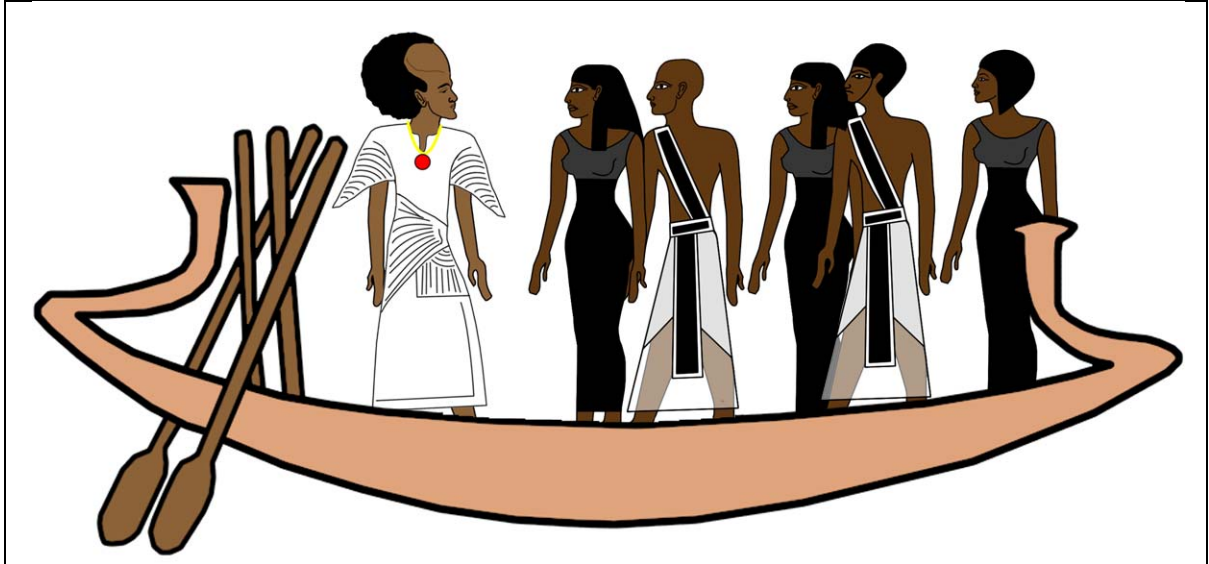

70. **Yaqub** felt if he could successfully separate the darker gene from the lighter gene then he could graft the **Ebonoid** tribe into its last stage, which would be **Albinoid**. **Yaqub** planned to create a tribe of **Albinoids**, which he discovered was weaker than the **Ebonoid** gene (which would be unlike) to rule the **Ebonoid** nation for 6000 years

71. When **Yaqub's** followers learned of his new wicked plan and learned that he was killing and throwing babies overboard into the ocean, 95% of his followers lost their loyalty to **Yaqub**, and abandoned his mission and jumped ship

72. As **Yaqub's** fleet of ships sailed around Africa, and people who lost loyalty to his mission would jump ship into the areas which are now Egypt, Sudan, Ethiopia, Kenya, Djibouti, Somalia, Mozambique, Namibia, Senegal, Morocco, and Tunisia

73. 10% of the original 60,000 of **Yaqub's** followers betrayed Yaqub and jumped ship, 85% of the original 60,000 of **Yaqub's** followers jumped ship because they were confused why he would do such a horrible

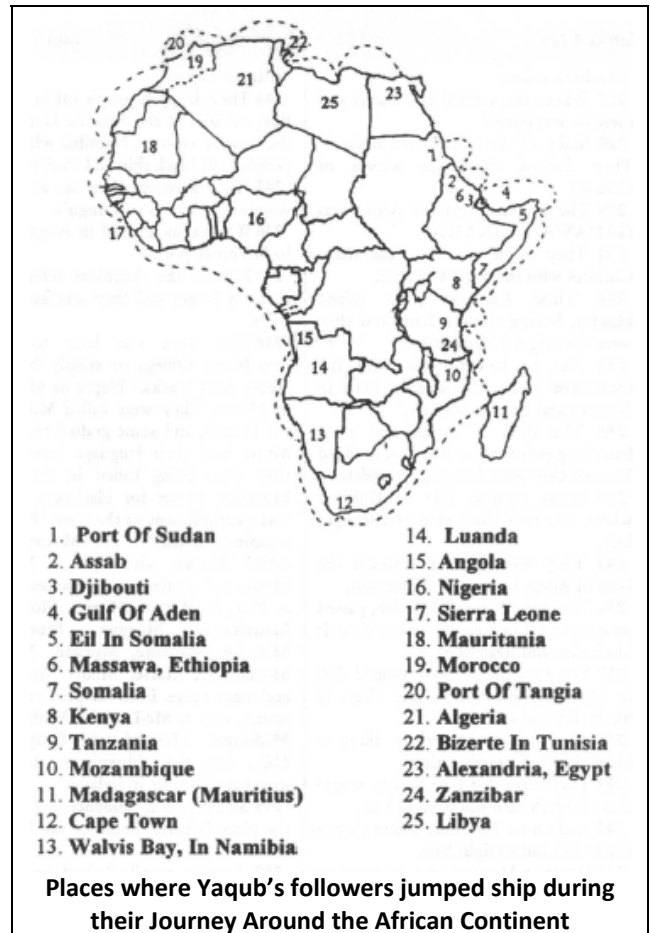

thing, leaving only 5% of the original 60,000 of **Yaqub's** followers who actually made it to their destination of **the Island of Patmos** in the **Aegean Sea**

74. As King on his Island, **Yaqub** set up **Birth Control** and **Planned Parenthood** laws which would contribute to his plan of **Negative Eugenics** and **genocide** to breed his **Albinoid** tribe.
75. **Yaqub** made it a law that only the lighter complexion people could have children. People with the Darker complexions were put to death, and when children were born, Nurses were ordered to have the darker babies killed by pricking the brains with a sharp needle as soon as the child's head is out of the mother, but the lighter babies were allowed to live
76. **Yaqub's** aim was to kill and destroy the **Ebonoid** nation
77. **Yaqub** would have the dead bodies of the darker babies fed to wild beasts, and if they could not find a wild beast to feed the bodies to, they would take the dead bodies of the babies to a cremator to be burned --- This is the level of intense hatred **Yaqub** had in his heart
78. This process went on for years on **Yaqub's** Island as **Yaqub** trained his sons and grandsons to carry on his work after he died; **Yaqub** died at the age of 150 years old from a brain tumor
79. As the father of **Tricknology**, **Yaqub** taught his people a doctrine which would enable them to rule the world for 6,000 years; **Yaqub** also taught his people that **God is a spirit and a spook and not a man**; and **Yaqub** was the founder of the doctrine that *"unlike attracts and like repels"*
80. After 200 years on **Yaqub's** Island, all of the darker babies had been done away with, and all babies were born of a new tribe called the **Rubedoid** tribe. After another 200 years, all babies were born of an even newer tribe called the **Citrinoid** tribe. And finally, after another 200 years, which makes **600 years total**, all the babies born on **Yaqub's** island were of **Yaqub's** desired **Albinoid** tribe

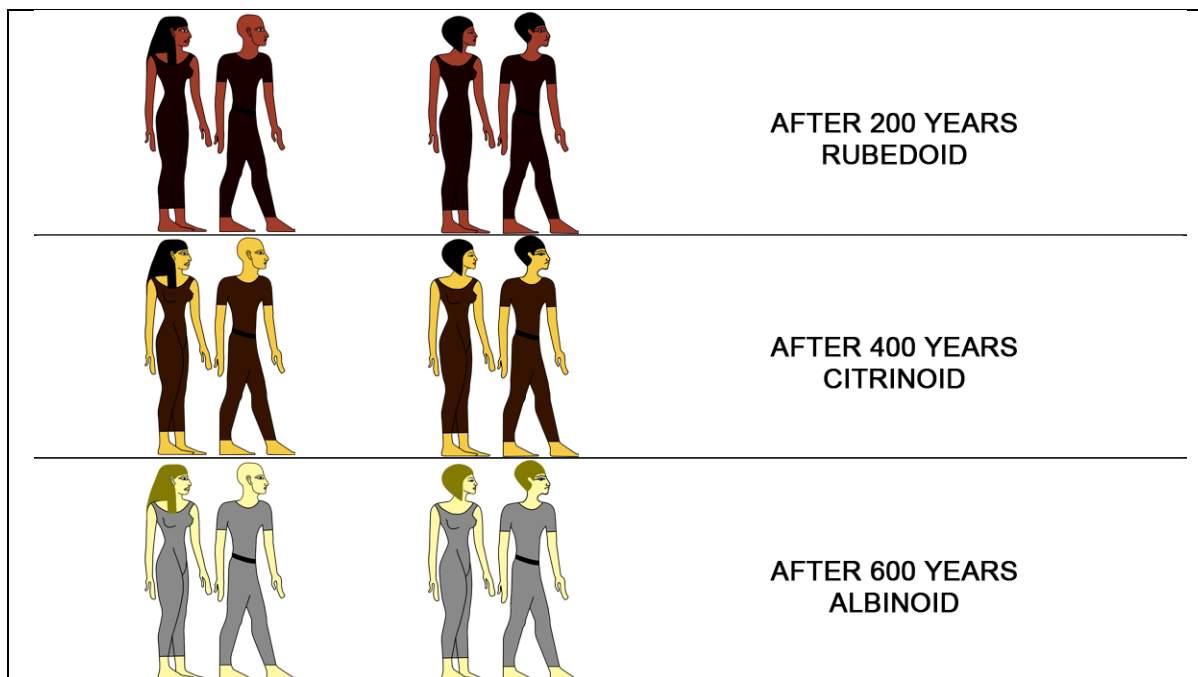

81. It took 600 years to breed Yaqub's **Albinoid** tribe, and every imagination of their heart and all of their actions were wicked continuously. The evilness of the **Albinoids** not only effected themselves, but also affected the other peoples of the world
82. **Yaqub's Albinoids** returned to the city where they were exiled from, 20 miles outside of the present day city of **Mecca, Saudi Arabia**
83. Once, back in the city, it took only 6 months for **Yaqub's Albinoids** to cause chaos and war amongst the **Ebonoid** people
84. The King of the **Ebonoid** people realized that it was **Yaqub's Albinoids** who were causing all the trouble, and the King made a decree to drive **Yaqub's** evil **Albinoids** from amongst them
85. The King rounded up all of **Yaqub's Albinoids** and stripped them of their clothing, and put an apron on them to hide their nakedness, and sent his army with them across the desert to cross the burning sands into the place which is modern day **Europe**

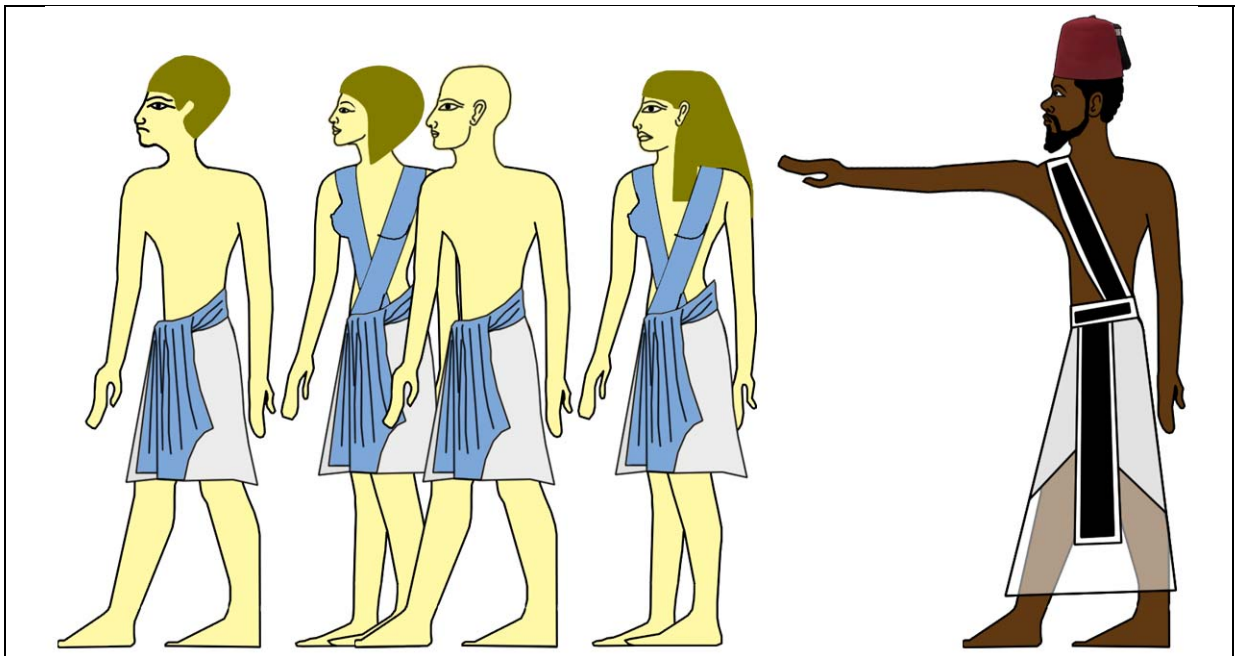

86. **Yaqub's Albinoids** were roped into the mountains and caves and the King's Army would patrol the area to make sure **Yaqub's Albinoids** stayed in the mountains and caves for 2,000 years to ensure that these people are kept away from the **Ebonoid** people
87. During this 2,000 year period living in the mountains and caves without anything to start civilization, **Yaqub's Albinoids** became shameless, morales, psychopathic, savage beasts and lost all sense of shame and started going nude, and In the winter they wore animal skins for clothes and grew hair all over their bodies and faces like all the other wild animals. **Yaqub's Albinoids** started walking on their hands and feet like all animals; and, learned to climb trees as well as any of the animals. At

night, they would climb up into trees, carrying large stones and clubs, to fight the wild beasts. **Yaqub's Albinoids** tamed the wolves and dogs to live in the caves with them, and after some time the dog held a high place among their family becoming their best friend

88. After 2,000 years of living in the Caves, the wickedness of **Yaqub's Albinoids** was observed, and an **Ebonoid** man named **Mashah** was sent to civilize them

89. **Mashah** led **Yaqub's Albinoids** out of the caves, however once out of the caves, **Yaqub's Albinoids** killed **Mashah**

90. Free from the caves, **Yaqub's Albinoids** went on a rampage throughout the Earth conquering and subjecting the **Ebonoid** people, pitting one against the other using the idea of "divide and conquer"

91. **Yaqub's Albinoids** would rape **Ebonoid** women, creating mixed offspring with confused identities

92. **Yaqub's Albinoids** began to execute **Yaqub's** plan for them to rule the world for 6,000 years

93. A man named **Hamdu**, attempted to teach **Yaqub's Albinoids** to convince them to end their devilishment, however this was still 1400 years before the end of **Yaqub's Albinoids** 6,000 year period of dominion over the Earth

94. And so, **Yaqub's Albinoids** ruled the Earth for 6,000 years spreading their devilishment, evil, pain, suffering, and oppression to the **Ebonoid** people of the Earth as designed by the **Big Head Scientist Yaqub**

95. The events of **Yaqub** occurred on this Earth approximately 6,600 year prior to this writing, and the **24 wise Elder Scientists of the Inner Earth** foresaw and prophesized the birth of **Yaqub** 15,000 years

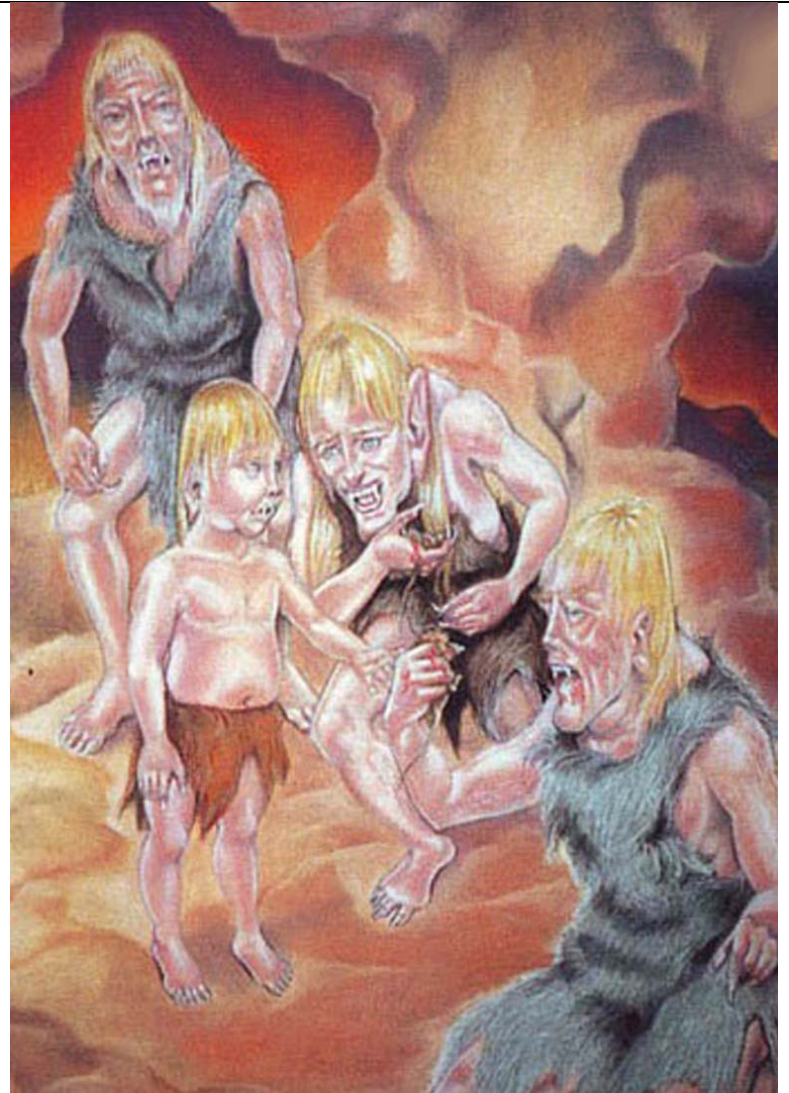

Yaqub's Albinoid Tribe

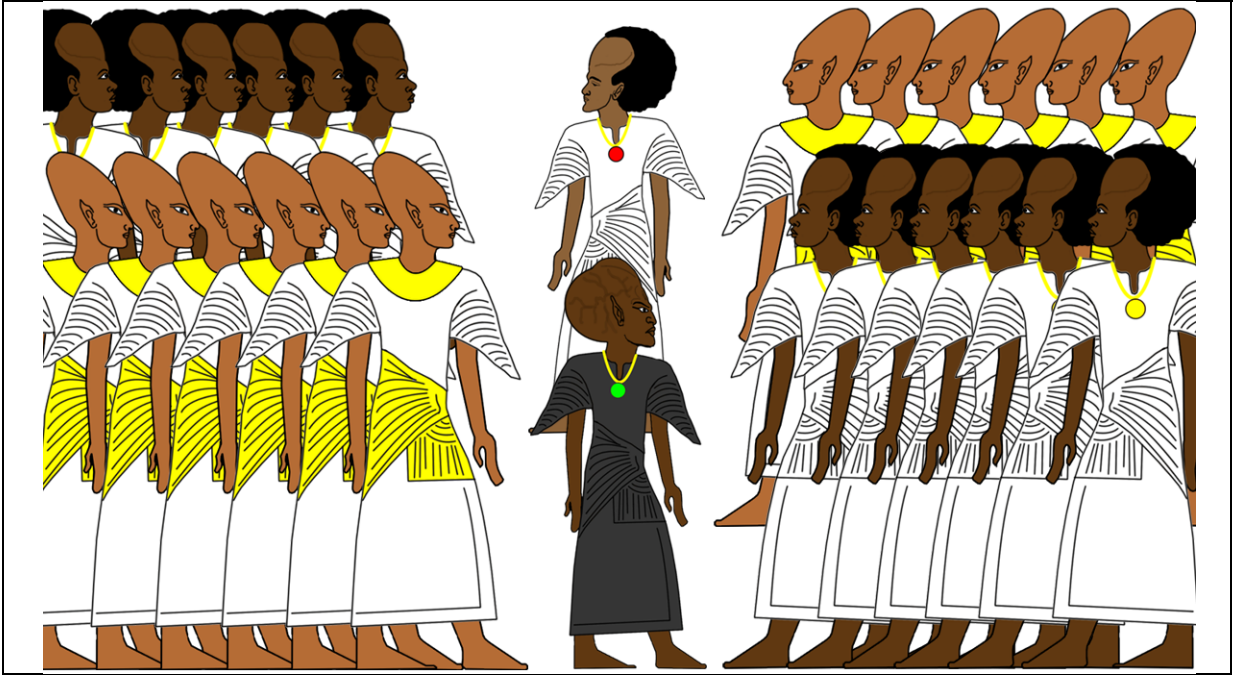

96. **The 24 wise Elder Scientists of the Inner Earth** were aware of the birth of **Yaqub**, and they were aware of the things **Yaqub** would do before **Yaqub** was even born
97. **The 24 wise Elder Scientists of the Inner Earth** predicted that in the year 8,400, this man **Yaqub** would be born, and when this man is born, he will change civilization and the world, and produce a new tribe of people, who would rule the original **Ebonoid** people for 6,000 years, from the 9,000th year to the 15,000th year
98. After the 6,000 year rule of **Yaqub's** people, the **Ebonoid** people would give birth to one whose wisdom, Knowledge and power would be infinite. One, whom the world would recognize as being the greatest and mightiest since the creation of the universe, and, that **Yaqub's** old warring wicked world would be removed and destroyed, and the **Ebonoid** nation would be restored into power to rule forever and to establish a world of peace and righteousness.
99. This great redeemer of the **Ebonoid** people who was predicted by **the 24 wise Elder Scientists of the Inner Earth** to bring balance back into the world, is known under many names, titles, and attributes including: He who has no equal, He who there never was anyone like, the Supreme Being, the mighty, the wise, the best knower, the light, the life giver, the Guide, the all-powerful, he who knows how to reproduce the universe, and the people of His choice...
100. ...But his Mother calls him **Yashmal**...

101. **Yashmal** was the son of **Princess Radiyyah** of The **Shuyukh** family and **Prince Haatif** The **Siyniyn** family
102. **Yashmal's** parents, **Princess Radiyyah** and **Prince Haatif**, married each other in order to establish peace between their two quarrelling tribes
103. However, the union of **Princess Radiyyah** and **Prince Haatif** was more than mere chance, their union was specifically guided and selected by **the 24 wise Elder Scientists of the Inner Earth** who were also **Eugenicists** and **Genetic Engineers**, and they knew that the offspring of the union between **Princess Radiyyah** and **Prince Haatif** would be the personification of **Order** to balance out and offset the **Chaos** of **Yaqub**, who was the offspring of **Yishawk** and **Princess Lusina**
104. **Yashmal** began his education on the day he was born as is the custom amongst members of the **Shuyukh**
105. It would be unheard of for a member of the **Shuyukh** to wait until the age of 4 to start school unless the child was mentally handicapped or retarded
106. Being part **Shuyukh** and part **Siyniyn**, **Yashmal's** head was noticeably larger than the other members of the **Shuyukh** and **Siyniyn**
107. **Yashmal** had an enormous head, two brains, and a third **enlarged pineal gland** which sat in the center of his two brains, making the top of his head appearing to be shaped like 3 orbs
108. Amongst the **Shuyukh** and **Siyniyn**, **Yashmal** would be called "**The Big Head Scientist**". However, amongst these tribes, this statement was not taken to be an insult but rather a compliment alluding to the individual's **intelligence** in the same way that saying "**Big Muscles**" alludes to an individual's **strength**

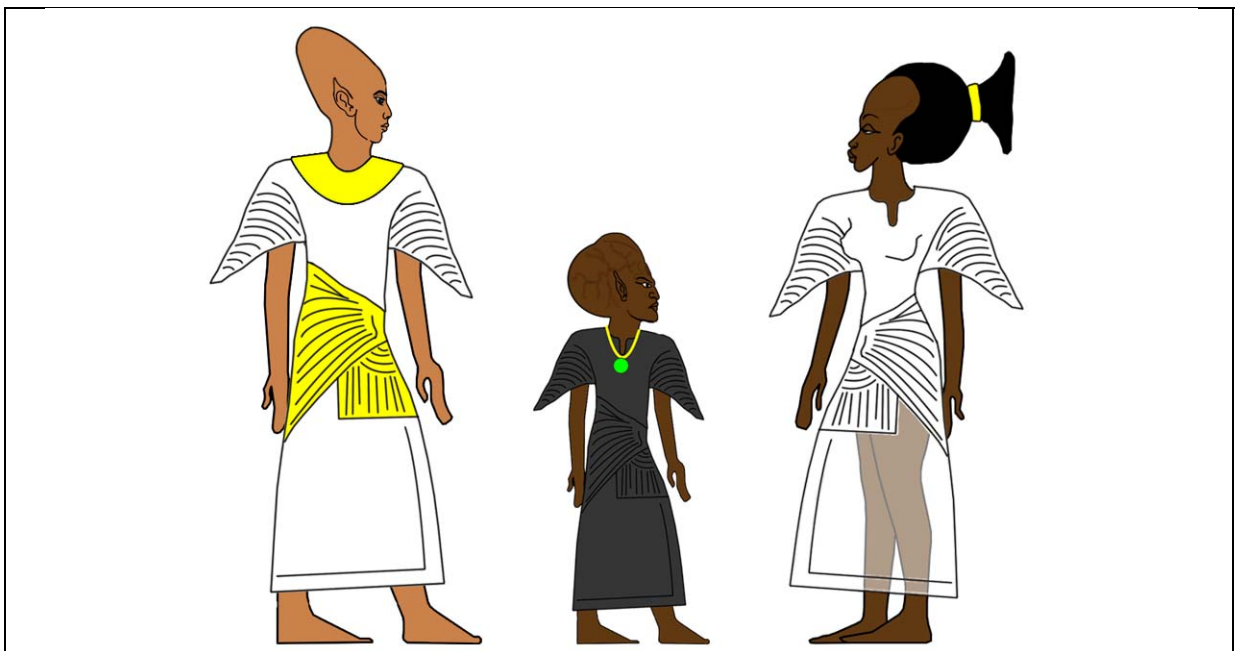

109. Since **Yashmal** was raised in his native land amongst his people who looked like him, he did not suffer from the same ridicule, mockery, and low-self esteem which plagued his cousin **Yaqub** who grew up in a foreign land amongst other than self and kind

110. As a child, **Yashmal** was an exceptional prodigy and a genius. **Yashmal** was also told stories of the evil activities which transpired at the hands of his cousin **Yaqub**

111. One day, when **Yashmal** was 9 years old, he was playing with two **electromagnets** in the home of his Grandfather **King Fuquur**, and noticed that electrons flowing in the **same direction** through two electromagnets would create the magnetic phenomenon of **attraction**, and that electrons flowing in **opposite directions** through two electromagnets would create the magnetic phenomenon of **repulsion**. By observing this, **Yashmal** realized that “**like flowing energies create attraction and unlike flowing energies create repulsion.**” Thus, **Yashmal** was inspired with a **determined idea** to direct the **flow of mental energy** of the **Ebonoid** people of the planet in the same direction so that the **Ebonoid** people of the planet will be unified again to be **strong and righteous**, and bring peace and balance back to the Earth forever

112. Upon coming to this realization, **Yashmal** looked up at his Grandfather **King Fuquur** and said, “Grandfather, when I get older, I am going to make a people strong and righteous, and I will eliminate the devilishment which has come into the world to show forth real power and wisdom, and bring back peace and supreme balancement forever”

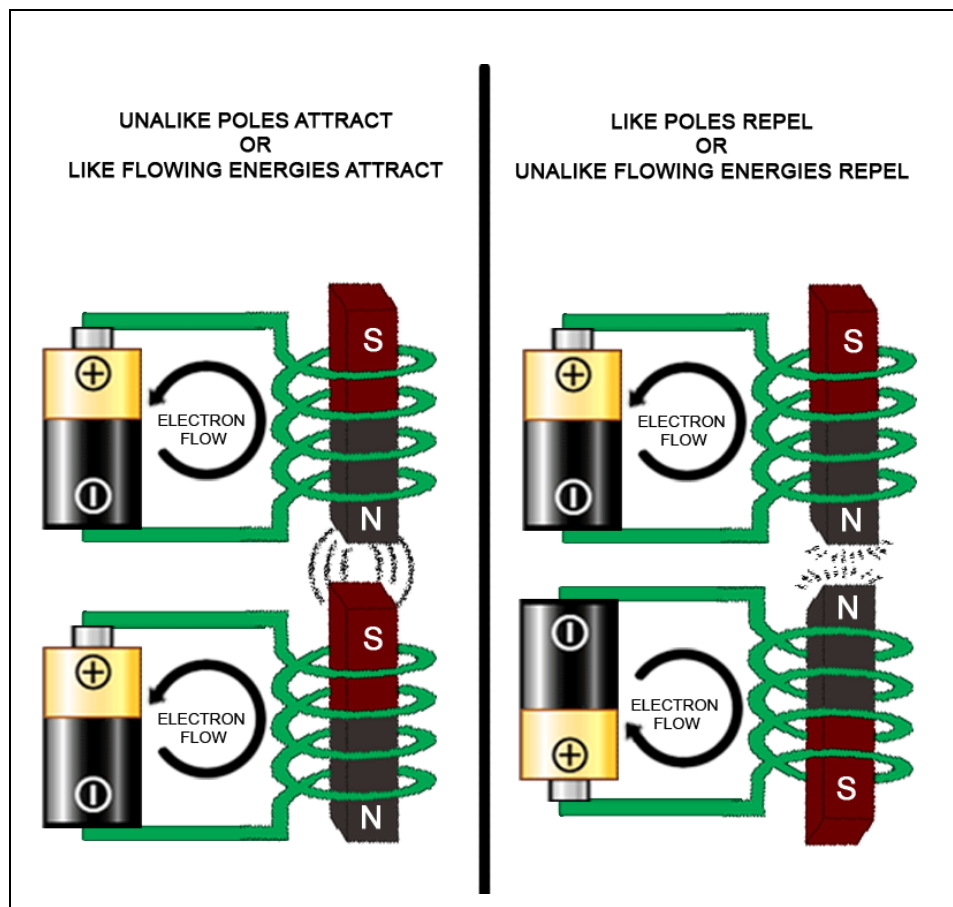

113. Grandfather **King Fuquur** said: “What will you make; someone to establish order and cause harmony in the world?”

114. **Yashmal** said: “Man plans and I plan, and surely I am the better planner,” and it was at that moment, the boy **Yashmal** first came into the knowledge of just who he was – born to establish order, bring peace, build, create, and be the redeemer to the **Ebonoid** peoples of Earth

115. It is common for members of the **Shuyukh tribe** to finish all of the course work taught in all of the colleges and universities of the surface world by age 9, but **Yashmal** finished by age 7

116. If it took a member of the **Shuyukh tribe** until age 18 to finish all of the course work taught in all of the colleges and universities of the surface world, then that person would surely be looked at as being mentally handicapped or mentally retarded

117. **Yashmal** finished all of the Advanced Universal sciences which are taught by the Schools in the Inner Earth by the time he was age 12, even though it is common to finish this course work by age 15, but **Yashmal** was a genius and a prodigy

118. After finishing school, **Yashmal** met with **the 24 wise Elder**

Scientists of the Inner Earth and told them of his intention to travel to the surface world as a bringer of peace and redeemer of the **Ebonoid** people

119. **Yashmal** was tried and tested by **the 24 wise Elder Scientists of the Inner Earth**, and once found worthy, at age 18, **Yashmal** traveled to the area presently known as the **Mwanza Region** near the countries of **Tanzania, Uganda, and Kenya** in **Africa**



120. **Yashmal** called his new Doctrine “**Teachnology**” and his holy book was called the **Book of Teachnology of 720°**, which was in a “**Question and Answer**” format designed to get the mental energies of the listeners flowing in the same direction which would in turn create unity, harmony, and attraction amongst kindred

121. **Yashmal**’s new doctrine was so powerful that he had millions of people from all of the tribes on the Earth coming to hear his message and aspiring to be a part of his mission

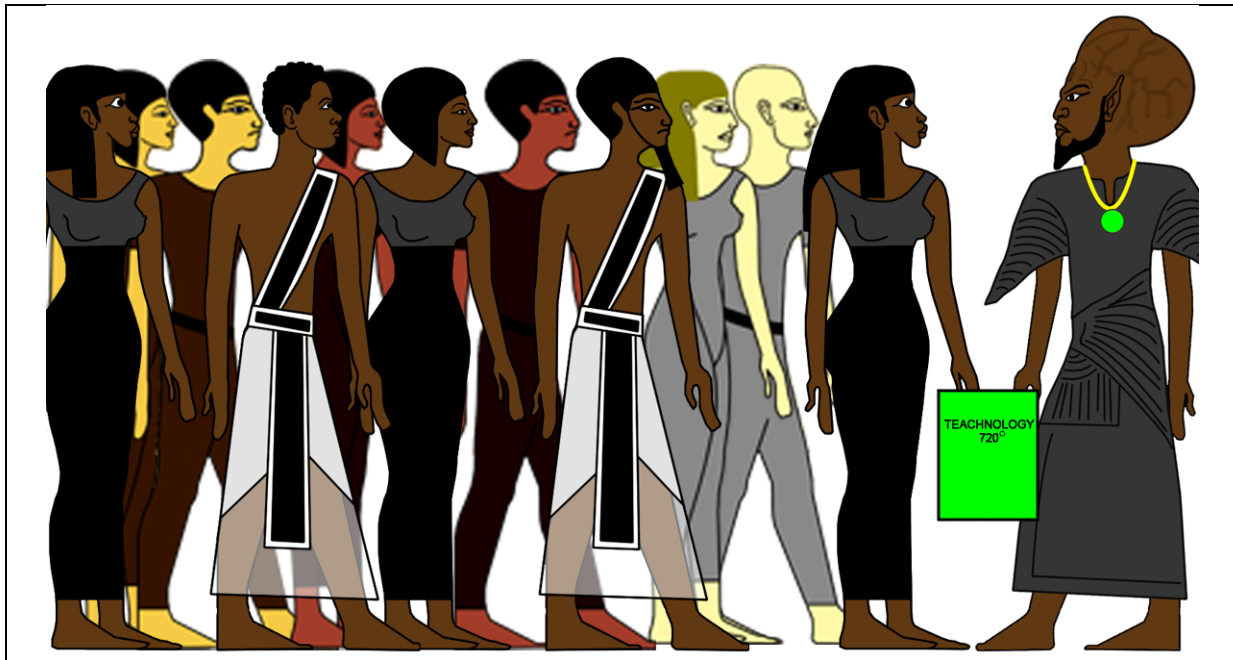

122. However, from the millions of followers that he gained on the surface of the Earth, **Yashmal** only selected **144,000** which he called “**the chosen few**” to be a part of the next phase of his plan, and when **Yashmal** and his chosen few departed, he told the people on the surface of the Earth he would be back in 1 Day

123. So **Yashmal** selected 41,150 **Ebonoid** females and 41,140 **Ebonoid** males for a total of 82,290 people from the original **Ebonoid** tribe; 10,285 **Rubedoid** females and 10,285 **Rubedoid** males for a total of 20,570 people from the **Rubedoid** tribe; 10,285 **Citrinoid** females and 10,285 **Citrinoid** males for a total of 20,570 people from the **Citrinoid** tribe; and 10,285 **Albinoid** females and 10,285 **Albinoid** males for a total of 20,570 people from the **Albinoid** tribe; which made 144,000 people total

124. **Yashmal** took his followers into the Inner Earth through an opening beneath the Great Lake in the present day area known as the **Mwanza Region** in **Africa** to begin his **Eugenics Genetic Engineering** experiment of grafting the various tribes of people on the Earth back into the original **Ebonoid** tribe

125. **Yashmal** being a master Genetic Engineer who was **All Wise, Right, and Exact**, knew that it was not necessary to kill anyone in order to accomplish his goal because he had knowledge of the science of **dominant and recessive genes**

126. Knowing that the **Ebonoid** tribe was the first, then **Yashmal** knew the **Ebonoid** gene would be the most dominant, followed by the **Rubedoid** gene, followed by the **Citrinoid** gene, followed by the **Albinoid** gene

127. While inside the **Inner Earth** with his followers, **Yashmal** applied the science of dominant and recessive genes to design and engineer a system of **Arranged Marriages** by which the offspring born from each arranged marriage would have certain desirable qualities,

THE SCIENCE OF DOMINANT AND RECESSIVE GENES

		MOTHER	
		A	a
FATHER	A	AA	Aa
	a	Aa	aa

and in time over a period of 900 years, all of the derivative tribes would have been grafted back into the original **Ebonoid** tribe

128. **Yashmal** also observed that the Gene of the **Ebonoid** woman was the most dominant gene, and so **Yashmal** established the following rules of Arranged Marriages amongst his followers

129. 10,285 **Ebonoid** Women and 10,285 **Ebonoid** Men would marry to keep the **Ebonoid** gene pure

130. 10,285 **Ebonoid** Women would marry 10,285 **Rubedoid** Men

131. 10,285 **Ebonoid** Women would marry 10,285 **Citrinoid** Men

132. 10,285 **Ebonoid** Women would marry 10,285 **Albinoid** Men

133. 10,285 **Ebonoid** Men would marry 10,285 **Rubedoid** Women

134. 10,285 **Ebonoid** Men would marry 10,285 **Citrinoid** Women

135. 10,285 **Ebonoid** Men would marry 10,285 **Albinoid** Women

136. **Yashmal** would also keep 10 **Ebonoid** Women as wives for himself

137. The men and women were required to get married by age 19, and each couple were to have 2 children

138. Living in the **Inner Earth** where he was from, **Yashmal** was continuously regenerated and rejuvenated and did not die like his cousin **Yaqub** on the surface of the Earth

139. **Yashmal** was able to teach, socialize, laugh, play with the children, enjoy life, and observe the generations and progression of his followers over the centuries

140. The offspring of the **Ebonoid** Woman and the **Ebonoid** Man would always be **Ebonoid**

141. The offspring of the **Ebonoid** Woman and the **Rubedoid** Man would also be **Ebonoid** because of the strength of the **Ebonoid** Woman's genes

142. The offspring of the **Ebonoid** Woman and the **Citrinoid** Man would be **Ebonoid** 75% of the time, and **Rubedoid** 25% of the time, because of the strength of the **Ebonoid** Woman's genes

143. The offspring of the **Ebonoid** Woman and the **Albinoid** Man would be **Ebonoid** 75% of the time, and **Citrinoid** 25% of the time, because of the strength of the **Ebonoid** Woman's genes
144. The offspring of the **Ebonoid** Man and the **Rubedoid** Woman would be **Ebonoid** 75% of the time, and **Rubedoid** 25% of the time
145. The offspring of the **Ebonoid** Man and the **Citrinoid** Woman would be **Rubedoid**
146. The offspring of the **Ebonoid** Man and the **Albinoid** Woman would be **Citrinoid**

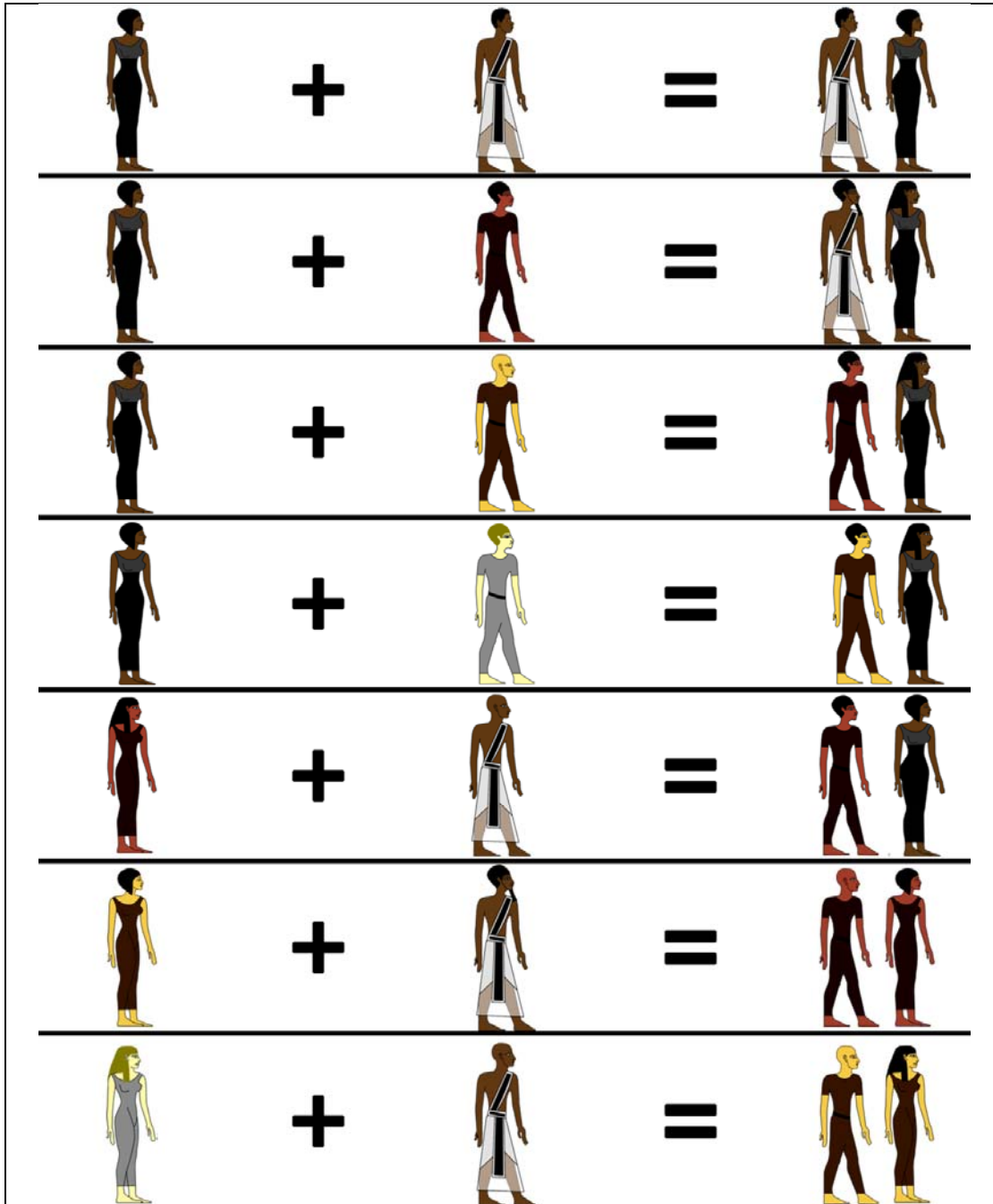

147. With the laws of arranged marriages in place, it would take **Yashmal's** chosen **144,000** people 46 Generations over the course of 900 years to be grafted back into the original **Ebonoid** tribe
148. During this time, for some generations recessive genes would tumble forward
149. After 12 generations, all of the **Albinoids** had been grafted back into the **Citrinoid, Rubedoid, and Ebonoid** tribes
150. After another 16 generations, all of the **Citrinoids** had been grafted back into the **Rubedoids and Ebonoids**
151. After another 18 generations, all of the **Rubedoids** had been grafted back into the **Ebonoids**, leaving only the original **Ebonoid** tribe
152. It was also observed that after 4 generations, if the **Albinoids** refused to mix in, then they would be unable to conceive offspring after the 4th generation
153. After 8 generations, if the **Citrinoids** refused to mix in, then they would be unable to conceive offspring after the 8th generation
154. After 16 generations, if the **Rubedoids** refused to mix in, then they would be unable to conceive offspring after the 16th generation
155. Just like Electrons flowing from atoms with more electrons to atoms with fewer electrons, it was necessary for the derivative tribes to mix back into the original **Ebonoid** tribe in order to get recharged and sustain and maintain their existence. However, because of the science of recessive and dominant genes, by mixing back into the original **Ebonoid** tribe, the derivative tribes would eventually be grafted back into the original **Ebonoid** tribe in time leaving only the original **Ebonoid** tribe on the surface of the planet
156. **As it was in the beginning, so shall it be in the end**
157. And so **Yashmal** smiled at this fact now having knowledge that the evil acts done by his cousin **Yaqub** would be reversed just by letting **Nature** take its course
158. The process of grafting the derivative tribes back into the original **Ebonoid** tribe took 900 years, and once completed, **Yashmal** took another 100 years to teach and train his followers how to control and conquer the evil which existed within themselves, rather than attempting to graft the evil out letting it manifest as a being
159. After the 1000 year period with **Yashmal** in the **Inner Earth**, **Yashmal** returned to the surface of the Earth to the area presently known as the **Mwanza Region** in Africa with 144,000 **Ebonoid** people
160. When **Yashmal** and his 144,000 followers returned, the people on the surface of the Earth said, "Yashmal, you said you would be gone for 1 Day, and you were true to your word, you have only been

gone for one day, but many of the people you have returned with are not the same people you left with! What have you done with our brothers and sisters?”

161. One of the **Ebonoid** women named **Qedara** who was one of **Yashmal**'s wives and one of the 144,000 spoke up and said, “I am the daughter and great descendant of your brothers and sisters which it seems to you left with **Yashmal** just yesterday, but we have been with **Yashmal** in the **Inner Earth** for 1000 years where he has taught us the science of genetics and how to rid the world of evil as well as conquer the evil within ourselves”

162. **Yashmal** spoke and said, “Indeed, one day in the Inner Earth can be like 1000 years”

163. **Yashmal**'s followers then proceeded to teach the **Ebonoid** people on the surface of the Earth the way to defeat the evil currently plaguing the Earth in the same way that **Yashmal** had taught them

164. **Yashmal** returned to the **Inner Earth** with his **Ebonoid** wife **Qedara** who spoke up in defense of him

165. After returning to the Inner Earth, **Yashmal** was elected to a seat as one of **the 24 Wise Elder Scientists of the Inner Earth**

166. **Yashmal** taught **Qedara** the secret to **Eternal Life** and they had many children together

167. **Yashmal** told **Qedara** that the **Ebonoid** woman is the Human representative of **Nature** on

the surface of the Earth, and thus the **Ebonoid** woman is the key to destroying the Evil plaguing the surface of the Earth, and bringing peace and balance back to the surface of the Earth

168. **Yashmal** told **Qedara** that it was not him who **the 24 Wise Elder Scientists of the Inner Earth** had prophesized about, it was her, the **Ebonoid** woman

169. **Yashmal** told **Qedara** that he was merely a conduit to allow her to bring balance back to the Earth

170. And so while **The Big Head Scientist Yashmal**'s followers execute his plan on the surface of the Earth, **Yashmal** and **Qedara** wait with their family in the **Inner Earth** for the Hereafter, that is to say, Here on Earth, After evil has been remove and peace and balance has been restored



Afterword

Danakil people, also known as the Afar people, of Eritrea, Djibouti, Ethiopia, and Somalia

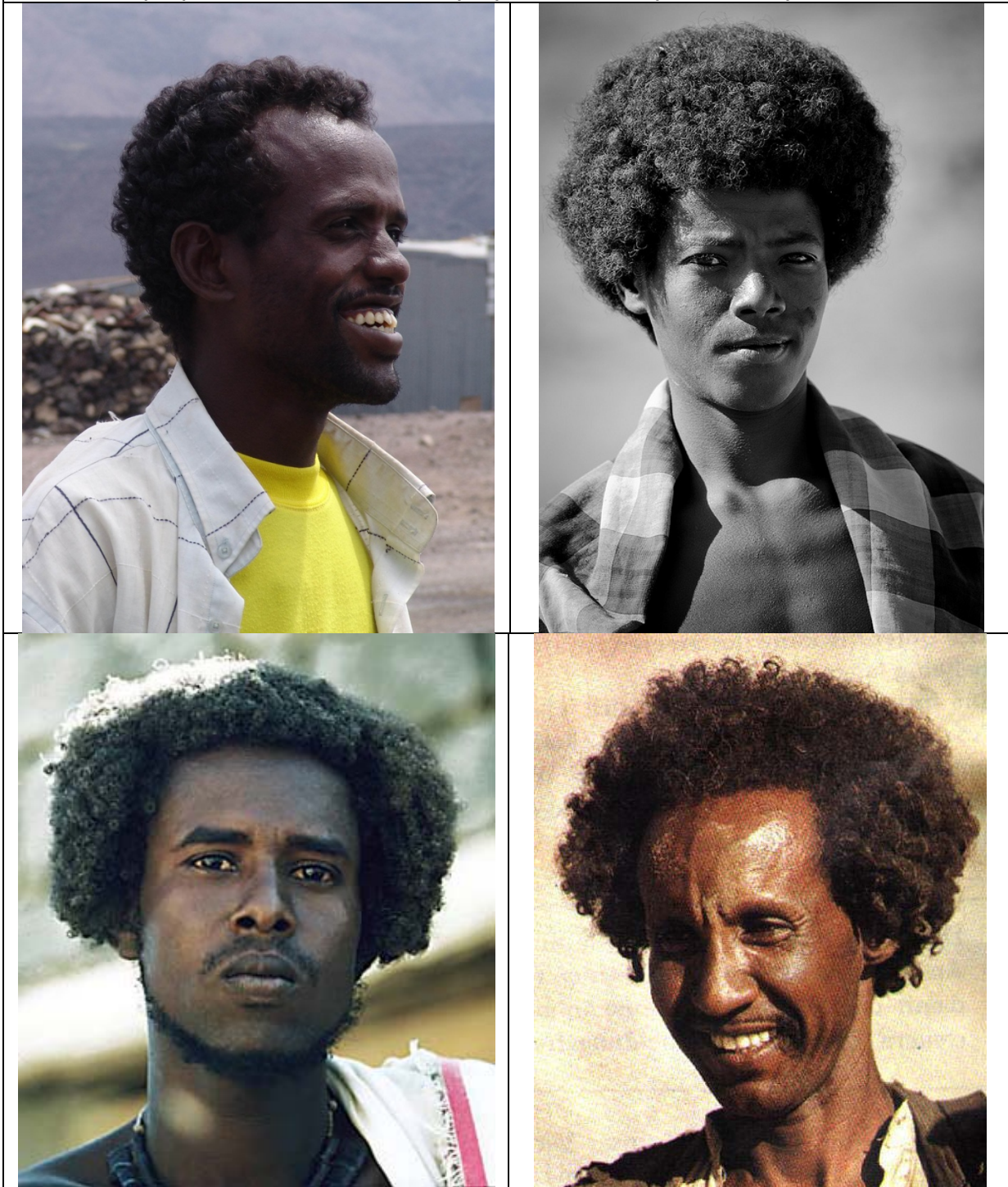

Mangbetu people in the African Congo

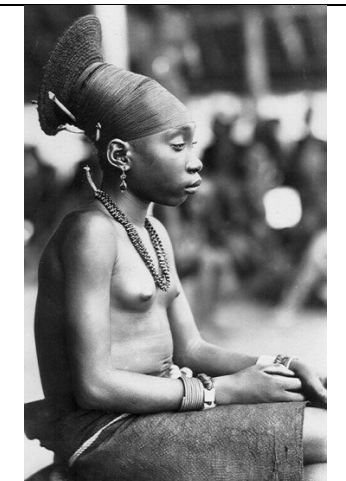
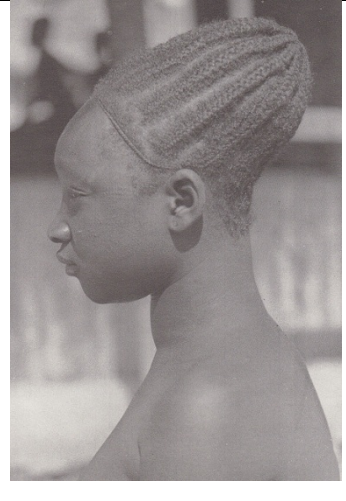
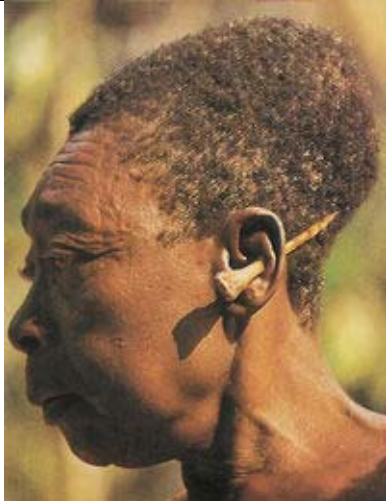
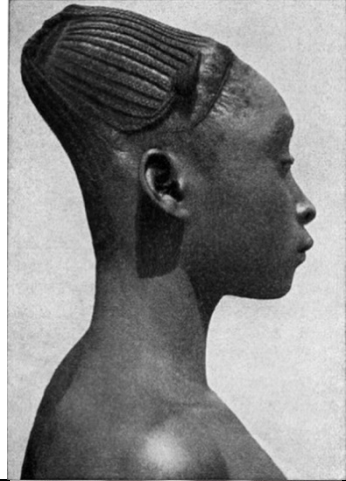
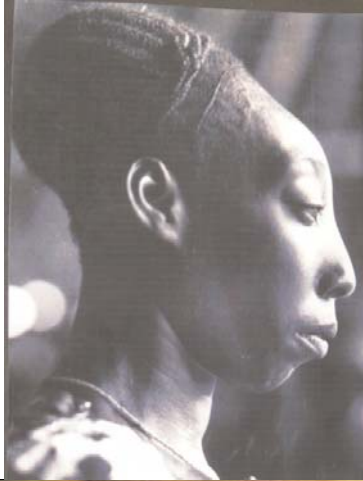

Skulls from the Paracas people of Peru



Statue from Ancient Egypt



Statues from Olmec Culture in Central America



Various Groups of People as Depicted on the Walls of the Tomb of the Egyptian Pharaoh Seti I

